

We get the pressure up

L3MW: an innovative pumping concept

Leistritz continues to meet industry demands by expanding the three screw pump technology. The L3MW pump focuses on much higher wear resistance during high pressure operation with abrasive and low viscosity liquids. The L3MW offers a better return on your pump investment by using optimal materials of construction and top manufacturing quality. This results in longer pump life and lower operating costs.

L3MW Applications:

- Pumping water based coolants for machine tools such as grinding machines, broaching machines, gun drilling and trepanning machines, as well as for complete transfer lines. The high pump pressure improves tool life and machining speed, especially with internal cooling.
- Hydraulic and cooling systems using water based fluids at high pressure.
- Service in the chemical, oil & gas and power industry, where solvents or similar fluids with poor lubricity are pumped.
- Gas turbine fuel injection with low viscosity fuels at high pressure.
- Lubricating and seal oil services API 614 applications.

Leistritz - An innovative, international pump manufacturer

Leistritz merges product know-how, and innovative thinking to each pump design. The focus is on product quality and customer requirements.

Leistritz AG, with headquarters in Nuernberg, Germany, was founded in 1905 and now has a total of approximately 1300 people employed in various plants. In 1924 the first screw pumps were manufactured. State of the art manufacturing systems, quality control management and environmental compliance, are the cornerstones of the pump technology. Today Leistritz is a leading screw pump manufacturer, offering screw pumps for a wide range of applications.



World wide product service

Product service is provided world wide. Our service centers in Europe, Asia and North America offer immediate service and repairs as well as spare parts with short delivery.

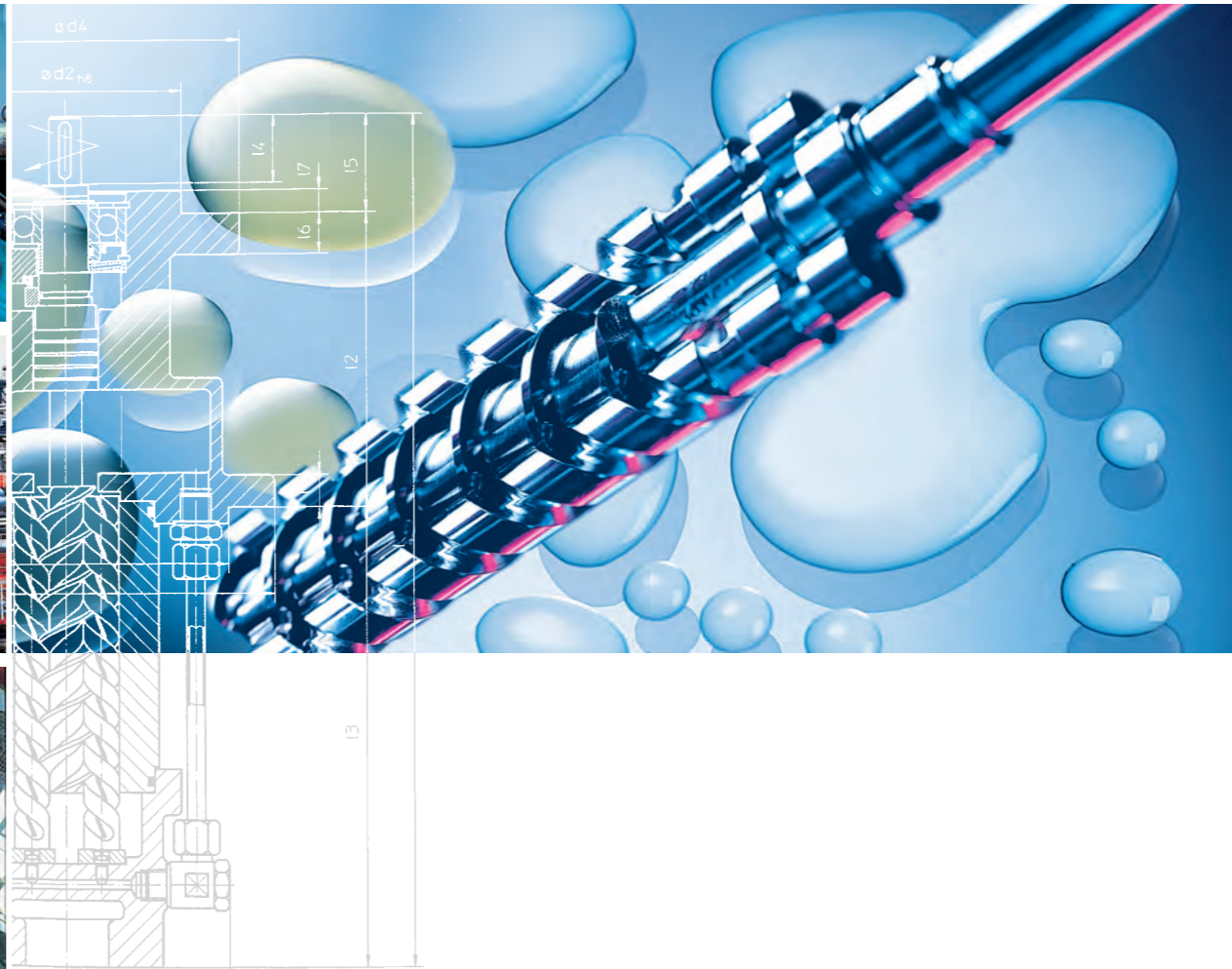

A Versatile Three Screw Pump L 3 MW

L3 MW

Leistritz

LEISTRITZ PUMPEN GMBH

Leistritz

LEISTRITZ PUMPEN GMBH

Leistritz Screw Pump Program

L2-Series

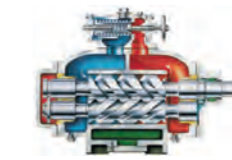

For light abrasive and corrosive, high or low viscosity fluids with poor lubricity
 ■ Capacity (max.): 1500 GPM (340 m³/h)
 ■ Diff. Pressure (max.): 240 PSIG (16 bar)

L3-Series



For high or low viscosity fluids with good lubricity.
 ■ Capacity (max.): 1000 GPM (228 m³/h)
 ■ Diff. Pressure (max.): 3000 PSIG (200 bar)

L4-Series

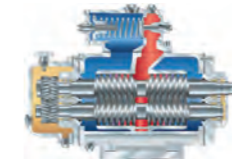

For corrosive, abrasive and high or low viscosity fluids with poor lubricity.
 ■ Capacity (max.): 4400 GPM (1000 m³/h)
 ■ Diff. Pressure (max.): 600 PSIG (40 bar)

L5-Series

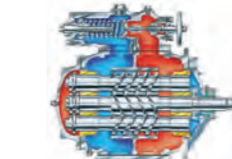

For lubricating and lightly abrasive fluids.
 ■ Capacity (max.): 6600 GPM (1500 m³/h)
 ■ Diff. Pressure (max.): 150 PSIG (10 bar)

MPP-Series

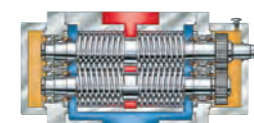

For multiphase fluids, mixtures of gas/oil/water with produced solids.
 ■ Capacity (max.): 377000 BPD (2500 m³/h)
 ■ Diff. Pressure (max.): 1500 PSI (100 bar)

Leistritz Product Range

Turbine and compressor blades for the aerospace and power industries

Extruders

Hydraulic Elevator Systems

Machine Tools

Screw Pumps

LEISTRITZ PUMPEN GMBH
 Markgrafenstraße 29 – 39
 D-90459 Nürnberg
 Postfach 30 41
 90014 Nürnberg
 Phone: +49-(0) 9 11- 43 06-0
 Fax: +49-(0) 9 11- 43 06-490
 E-Mail: pumpen@leistritz.com
 ■ www.leistritz.com

LEISTRITZ CORPORATION
 165 Chestnut Street
 Allendale, NJ 07401
 Phone: (201)-934-8262
 Fax: (201)-934-8266
 E-Mail: solson@leistritzcorp.
 ■ www.leistritz.com



A versatile high pressure pump

The new L3MW provides the latest in innovative pump design, resulting in an economical and durable product.

The L3MW is used for pumping:

- Water based emulsions
- Low viscosity mineral oils
- Fluids with poor lubricity

For special applications we can offer customized pump solutions. The pump performance data is shown in the tables to the right.

With multiple of rotor diameters and leads available, the L3MW typically meets your exact flow requirements.

The pumps can be mounted either vertically in a tank or horizontally mounted, facilitating your system design.

L3MW – Performance Characteristics	
Max. Capacity	160 GPM (600 l/m)
Max. Inlet pressure	150 PSIG (10 bar)
Max. discharge pressure	1500 PSI (100 bar)
Min. Viscosity	1 cSt (33 SSU)
Max. temperature	210 °F (100 °C)
Installation	Vertical tank mounted Horizontal dry mounted

Technical Highlights

High Wear Resistance

The Leistritz L3MW has a unique combination of materials for the liner and rotors to provide maximum wear resistance. The service life of each component is thereby substantially longer, leading to lower operating costs.

Liner Coating

The liner is coated with a proprietary thermoplastic, which is compatible with the pumped fluids. The elasticity of the liner and the hardness of the rotor minimizes the wear.

Hardening of the rotors

The hardening process of the rotors results in a very hard and deep surface layer for maximum service life and lower operating costs.

Low Noise Level

The pump operates at a very low noise level due to the hydro dynamically balancing of the rotors and a specially designed inlet area that minimizes inlet pressure drop.

Constant pressure increase

The rotor design, allows the fluid pressure to increase in small steps, eliminates pulsation's and also results in gentle handling of the pumped fluid.

Easy installation and space savings

In vertical mounting, the discharge flange is part of the end cover of the pump. Thus, no separate top plate or discharge piping is required. The mounting space required on the tank is also much smaller, allowing for quick retrieval of the pump if needed.

Service friendly design

The modular concept of the pump facilitates service and maintenance. While limited spare parts to be kept on stock.

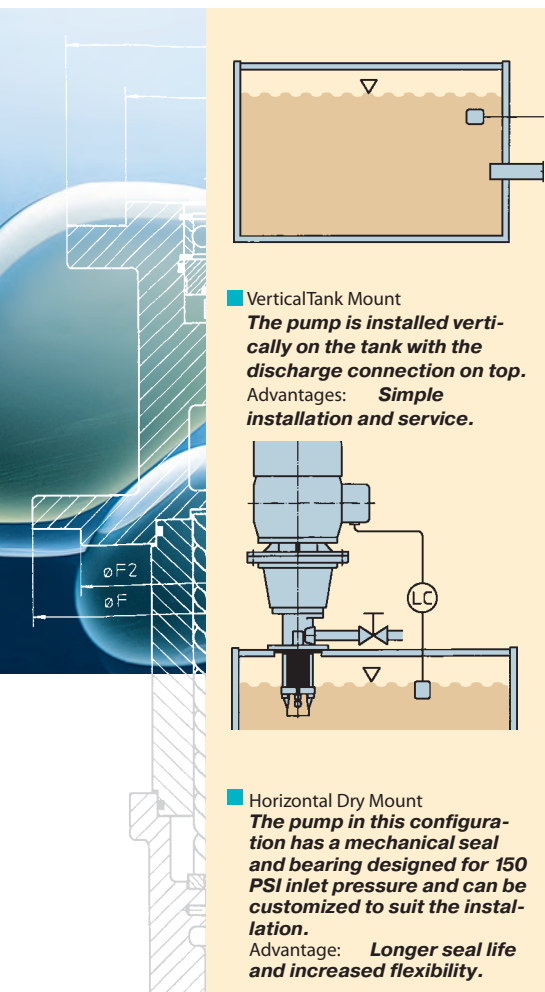

The axial thrust arrangement of the idler rotors provides hydraulically balanced pump operation.
Advantage: Low noise level, longer service life.

Liner with Coating

The permanently greased ball bearing is protected either by a lip seal or mechanical seal.

Innovative Leistritz Design
The fluid independent thermoplastic liner and deep hardening of the rotors makes the pump very tolerant to low viscosities and solids in the pumped fluid. Advantage: Can handle a large variety of fluids, with different viscosities, temperatures and impurities.

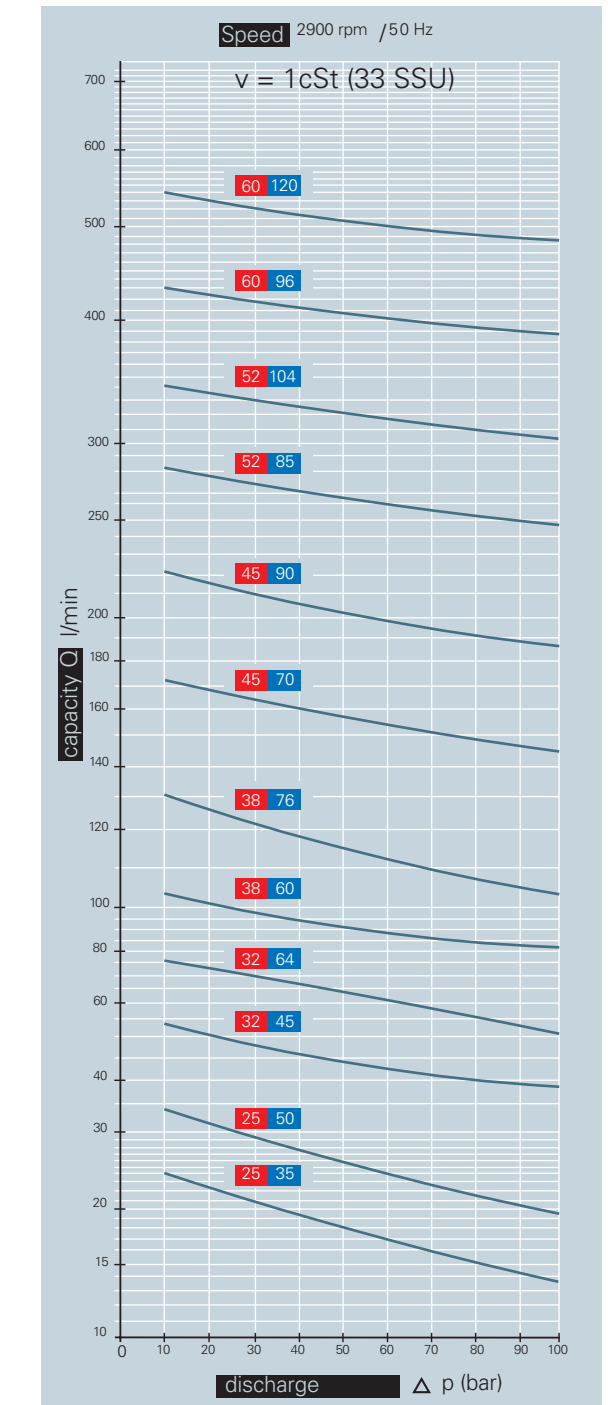
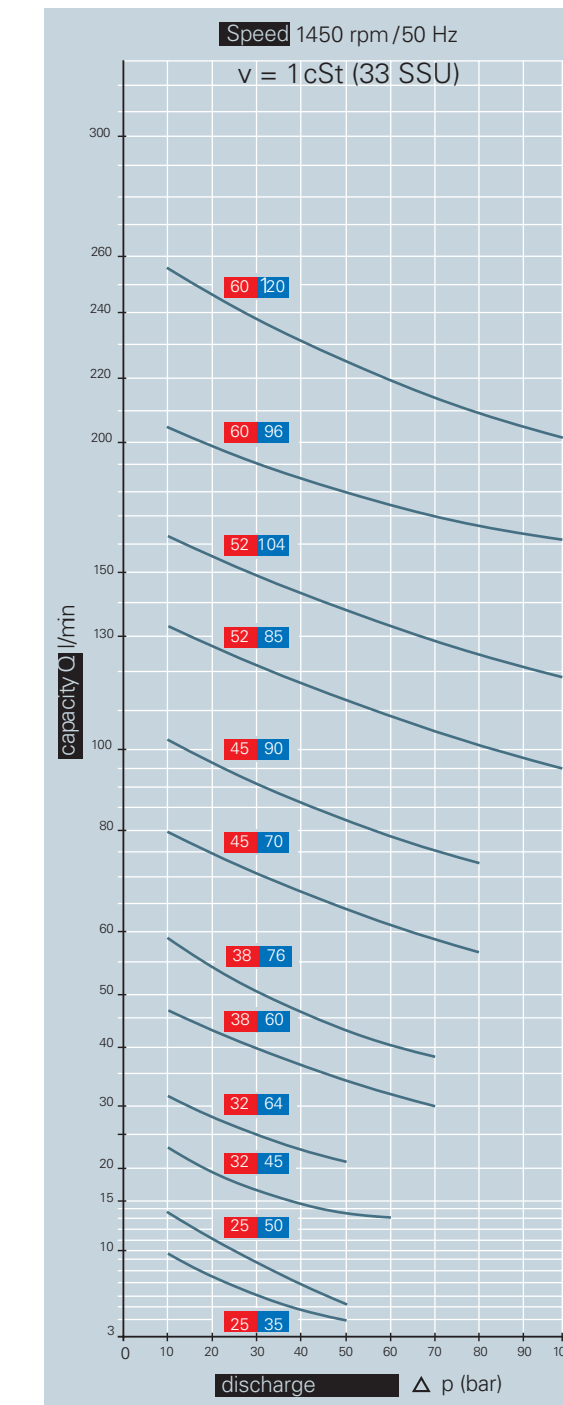

L3MW – Sizes

■ Rotor sizes [mm]

25	32	38	45	52	60
35	45	60	70	85	96
50	64	76	90	104	120

■ Rotor leads [mm]